

Varenummer: 20193V50V50762SW
 Beskrivelse: E+G T-rørs holder
 GN 193-V50-V50-76-2-SW

Mål

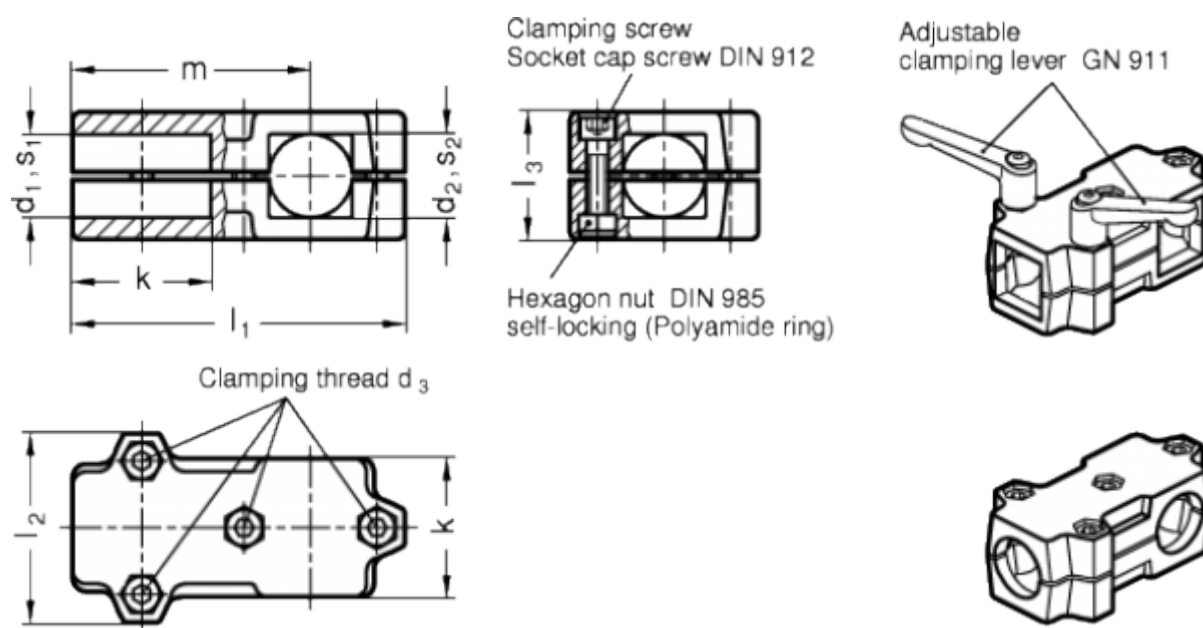

d1 = -	s1	= 50
d2 = -	s2	= 50
d3 = M10	Supplerende vare	= GN 911-M10-63
k = 76	Vægt i (g)	= 1054
l1 = 176		
l2 = 98		
l3 = 70		
m = -		